



BUDDY BRACE



PICOMED
Mobility

Et komplett setesystem til våre stoler



- Tally LB
- LB
- Dyna
- EV01
- EV03
- Xtreme



TÜV Godkjent, CE merket
og kollisjonstestet på alle
våre aktuelle rullestoler.



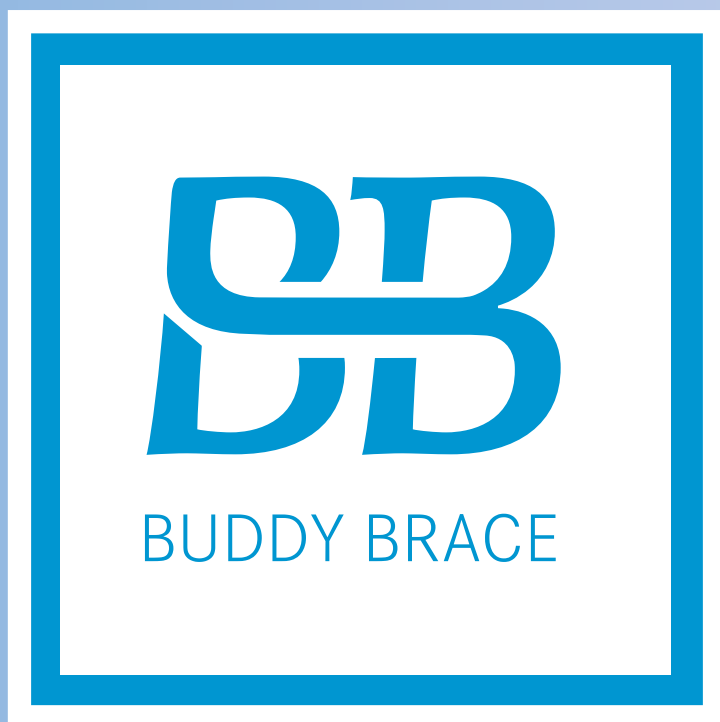

BEK RYGGSTØTTER

BEK SHIFT

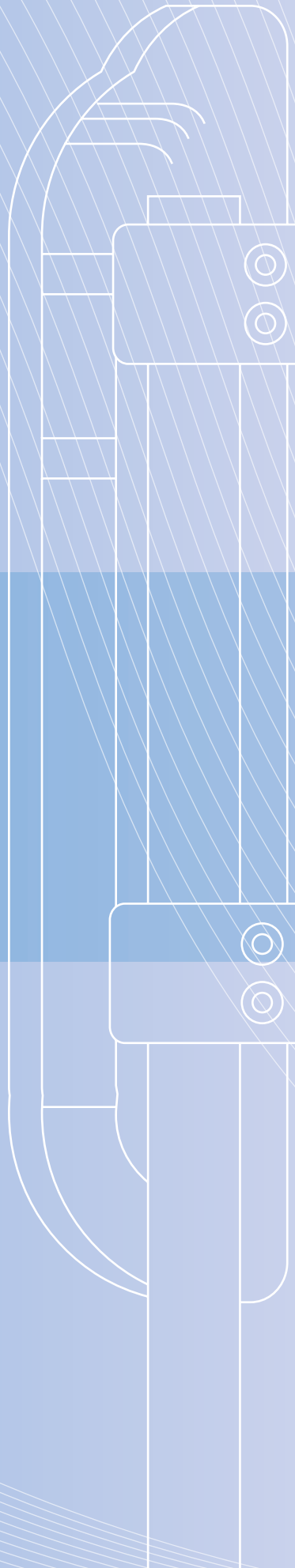

Trekk	Vekt bruker	Rygg-bredde	Rygg-høyde	Garanti	Kollisjons-testet	Sertifiseringer	Flammehemmende test
Sømløse og pustende	Maks 150 kg	fra 26 til 54	fra 30 til 55	2 år	På manuelle og elektriske rullestoler		laboratorium Rheinland TÜV-godkjent



1 Svært justerbar posisjoneringsryggstøtte

2 Bevegelsesfrihet med justerbare sidestøtter

3 Tilpasningsdyktig behagelig polstring med pustende trekk

MÅL

Bek	Rullestol-bredde	Rygg-bredde (A)	Rygg-høyde (B)
	24 - 28 cm	26 cm (M0)	30 cm
	26 - 30 cm	30 cm (M1)	35 cm - 40 cm
	30 - 34 cm	34 cm (M2)	40 cm - 45 cm
	34 - 38 cm	38 cm (M3)	45 cm - 50 cm
	38 - 42 cm	42 cm (M4)	45 cm - 50 cm - 55 cm
	42 - 46 cm	46 cm (M5)	45 cm - 50 cm - 55 cm
	46 - 50 cm	50 cm (M6)	55 cm
	48 - 52 cm	54 cm (M7)	50 cm

TREKK

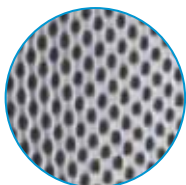

PUSTENDE
BAKSIDE



SKLISIKKER
BAKSIDE

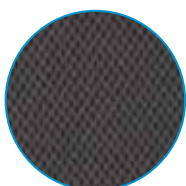

PUSTENDE
KONTAKTSIDE



POLSTRINGER

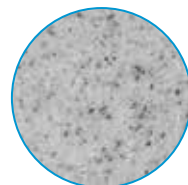

TEMPUR



PUSTENDE

MONTERINGSSYSTEMER



ATSKILTE JUSTERBARE
MONTERINGSFESTER



HELE JUSTERBARE
MONTERINGSFESTER



2 cm

2,2 cm

2,5 cm

SIDESTØTTE PAD SUPPORT

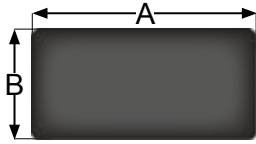

MÅL PAD

	S	M	L
A	11,0 cm	14,0 cm	18,0 cm
B	9,0 cm	10,0 cm	12,0 cm



JUSTERING AV STØTTEAVSTAND

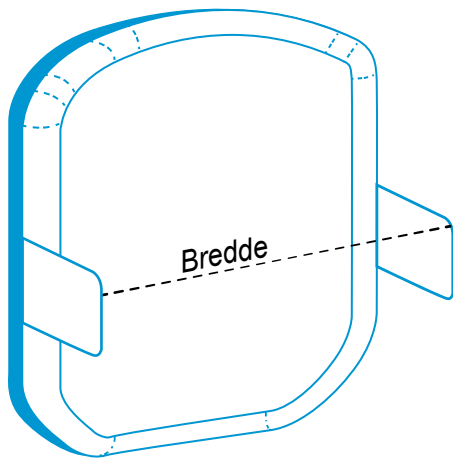

Rygg- bredde	Bredde med Pad S		Bredde med Pad M/L	
	min.	maks	min.	maks
M0 (26 cm)	12,0 cm	25,5 cm	10,5 cm	24,0 cm
M1 (30 cm)	16,5 cm	30,0 cm	15,0 cm	28,5 cm
M2 (34 cm)	20,5 cm	34,0 cm	19,0 cm	32,5 cm
M3 (38 cm)	24,5 cm	38,0 cm	23,0 cm	36,5 cm
M4 (42 cm)	28,5 cm	42,0 cm	27,0 cm	40,5 cm
M5 (46 cm)	32,5 cm	46,0 cm	31,0 cm	44,0 cm
M6 (50 cm)	36,5 cm	50,0 cm	35,0 cm	48,5 cm
M7 (54 cm)	40,5 cm	54,0 cm	39,0 cm	52,5 cm

MONTERINGSSYSTEMER

FAST

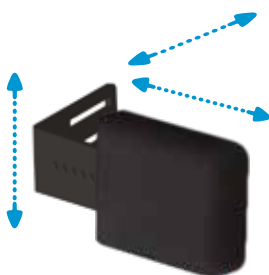

← JUSTERINGER →

SWING-AWAY

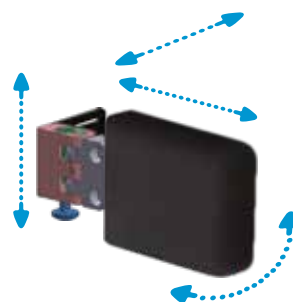

← JUSTERINGER →

AVTAGBAR

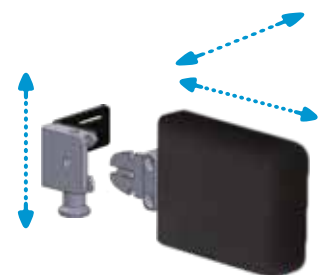

← JUSTERINGER →

SIDESTØTTE PAD HUG

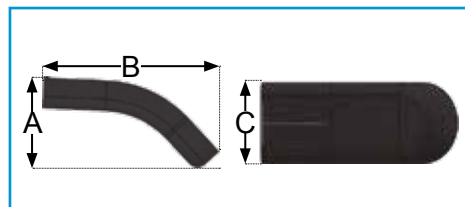

MÅL PAD			
	S	M	L
A	5,5 cm	10,0 cm	10,0 cm
B	12,0 cm	18,0 cm	24,0 cm
C	9,0 cm	9,0 cm	10,0 cm



JUSTERING AV STØTTEAVSTAND

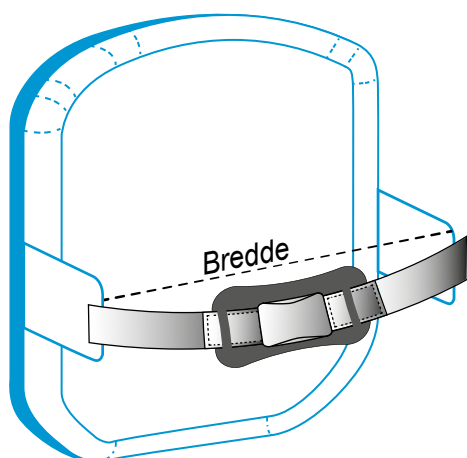

Rygg- bredde	Bredde med Pad S		Bredde med Pad M/L	
	min.	maks	min.	maks
M0 (26 cm)	12,0 cm	25,5 cm	10,5 cm	24,0 cm
M1 (30 cm)	16,5 cm	30,0 cm	15,0 cm	28,5 cm
M2 (34 cm)	20,5 cm	34,0 cm	19,0 cm	32,5 cm
M3 (38 cm)	24,5 cm	38,0 cm	23,0 cm	36,5 cm
M4 (42 cm)	28,5 cm	42,0 cm	27,0 cm	40,5 cm
M5 (46 cm)	32,5 cm	46,0 cm	31,0 cm	44,0 cm
M6 (50 cm)	36,5 cm	50,0 cm	35,0 cm	48,5 cm
M7 (54 cm)	40,5 cm	54,0 cm	39,0 cm	52,5 cm

MONTERINGSSYSTEMER



POSISJONERINGSPAD CONTOUR

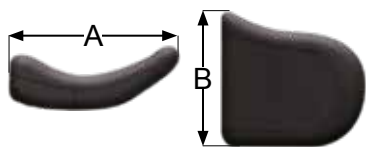

MÅL PAD			
	S	M	L
A	11,0 cm	15,0 cm	20,0 cm
B	8,0 cm	15,0 cm	20,0 cm



JUSTERING AV STØTTEAVSTAND

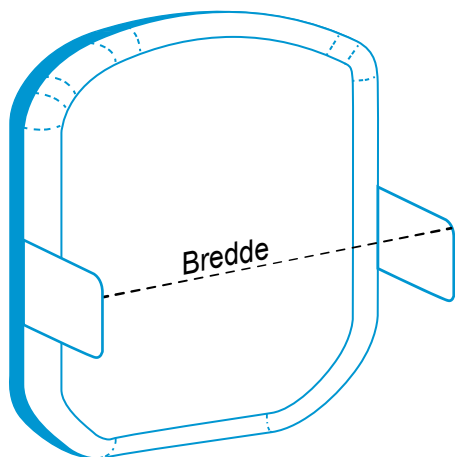

Rygg- bredde	Bredde med Pad S		Bredde med Pad M/L	
	min.	maks	min.	maks
M0 (26 cm)	12,0 cm	25,5 cm	10,5 cm	24,0 cm
M1 (30 cm)	16,5 cm	30,0 cm	15,0 cm	28,5 cm
M2 (34 cm)	20,5 cm	34,0 cm	19,0 cm	32,5 cm
M3 (38 cm)	24,5 cm	38,0 cm	23,0 cm	36,5 cm
M4 (42 cm)	28,5 cm	42,0 cm	27,0 cm	40,5 cm
M5 (46 cm)	32,5 cm	46,0 cm	31,0 cm	44,0 cm
M6 (50 cm)	36,5 cm	50,0 cm	35,0 cm	48,5 cm
M7 (54 cm)	40,5 cm	54,0 cm	39,0 cm	52,5 cm

MONTERINGSSYSTEMER

FAST

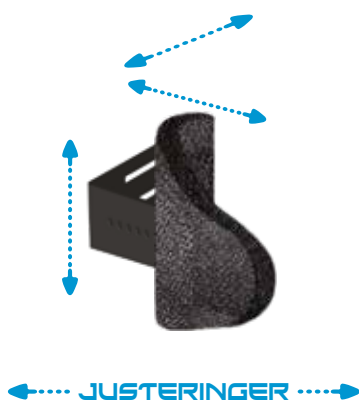

SWING-AWAY

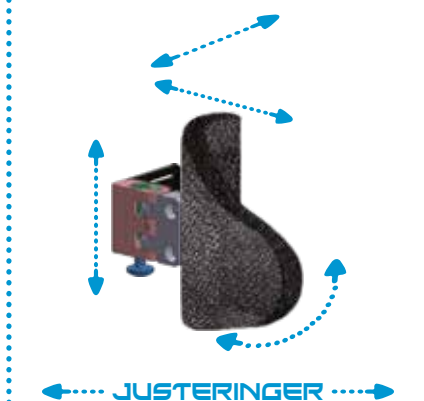

AVTAGBAR

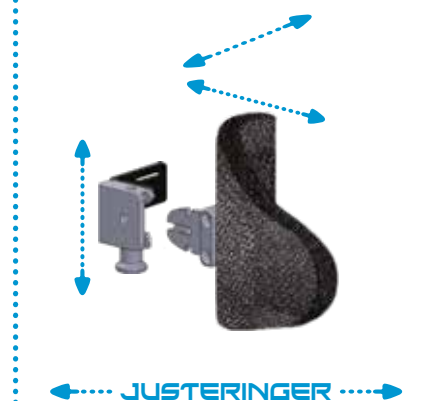

POSISJONERINGSPAD HOLD UP

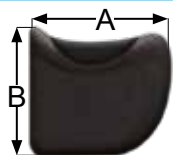

MÅL PAD

	S	M	L
A	12,0 cm	16,0 cm	21,0 cm
B	9,0 cm	16,0 cm	21,0 cm



JUSTERING AV STØTTEAVSTAND

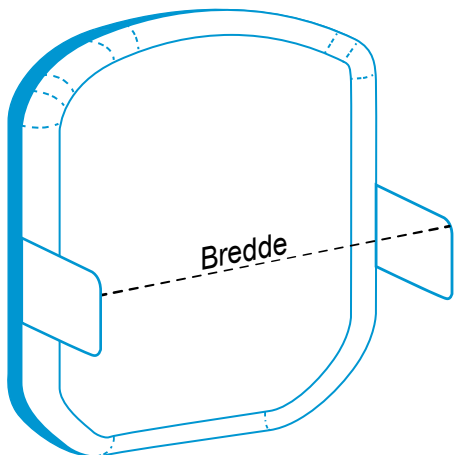

Rygg- bredde	Bredde med Pad S		Bredde med Pad M/L	
	min.	maks	min.	maks
M0 (26 cm)	12,0 cm	25,5 cm	10,5 cm	24,0 cm
M1 (30 cm)	16,5 cm	30,0 cm	15,0 cm	28,5 cm
M2 (34 cm)	20,5 cm	34,0 cm	19,0 cm	32,5 cm
M3 (38 cm)	24,5 cm	38,0 cm	23,0 cm	36,5 cm
M4 (42 cm)	28,5 cm	42,0 cm	27,0 cm	40,5 cm
M5 (46 cm)	32,5 cm	46,0 cm	31,0 cm	44,0 cm
M6 (50 cm)	36,5 cm	50,0 cm	35,0 cm	48,5 cm
M7 (54 cm)	40,5 cm	54,0 cm	39,0 cm	52,5 cm

MONTERINGSSYSTEMER

FAST

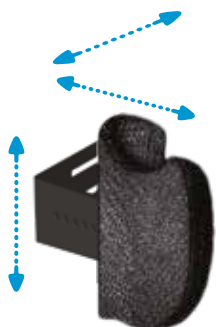

← JUSTERINGER →

SWING-AWAY

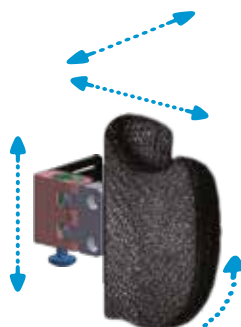

← JUSTERINGER →

AVTAGBAR

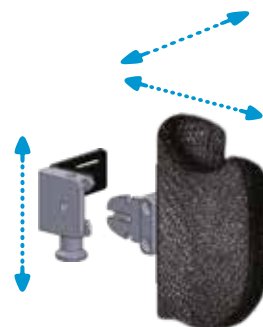

← JUSTERINGER →

BEK ROUND



Trekk	Vekt bruker	Rygg-bredde	Rygg-høyde	Garanti	Kollisjons-testet	Sertifiseringer	Flammehemmende test
Sømløse og pustende	Maks 150 kg	← cm → fra 26 til 54	↑ cm ↓ fra 30 til 55	2 år	På manuelle og elektriske rullestoler	CE	laboratorium Rheinland TÜV-godkjent



1 Omsluttende ryggstøtte egnet for brukere med nedsatt postural kontroll

2 Høyde og bredde justeringer av integrerte sidestøtter

3 Tilpasningsdyktig behagelig polstring med pustende trekk

MÅL

Bek	Rullestol-bredde	Rygg-bredde (A)	Rygg-høyde (B)
	24 - 28 cm	26 cm (M0)	30 cm
	26 - 30 cm	30 cm (M1)	35 cm - 40 cm
	30 - 34 cm	34 cm (M2)	40 cm - 45 cm
	34 - 38 cm	38 cm (M3)	45 cm - 50 cm
	38 - 42 cm	42 cm (M4)	45 cm - 50 cm - 55 cm
	42 - 46 cm	46 cm (M5)	45 cm - 50 cm - 55 cm
	46 - 50 cm	50 cm (M6)	55 cm
	48 - 52 cm	54 cm (M7)	50 cm

TREKK

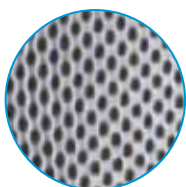

PUSTENDE
BAKSIDE



SKLISIKKER
BAKSIDE

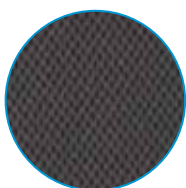

PUSTENDE
KONTAKTSIDE



POLSTRINGER



PUSTENDE

MONTERINGSSYSTEMER



ATSKILTE JUSTERBARE
MONTERINGSFESTER



HELE JUSTERBARE
MONTERINGSFESTER



2 cm

2,2 cm

2,5 cm

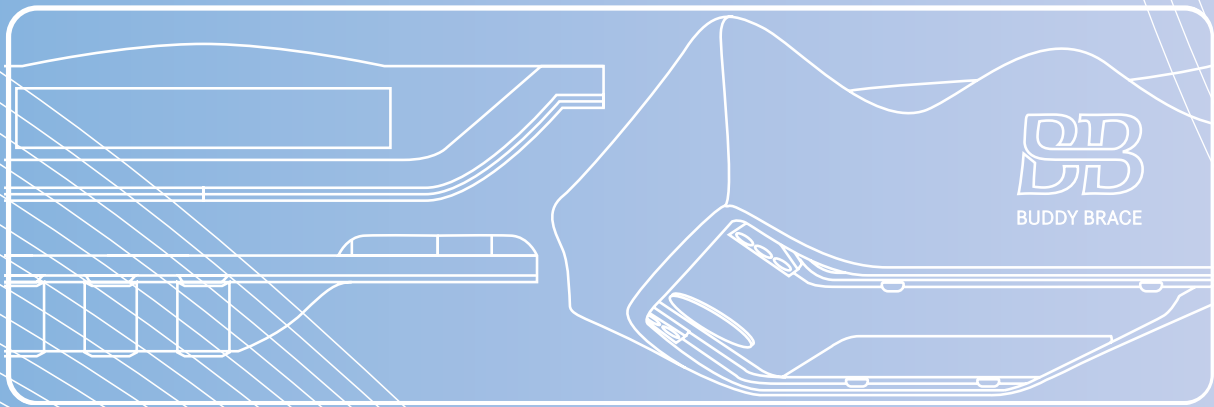
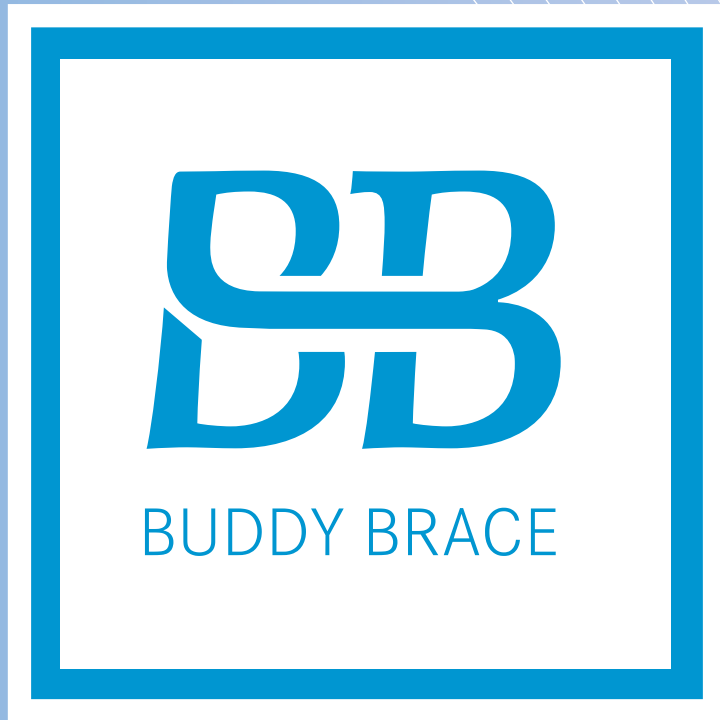

SETEPUTER

DYNAMIC



Trekk	Vekt bruker	Sete-bredde	Sete-dybde	Garanti	Kollisjons-testet	Sertifiseringer
 Sømløse og pustende	 Maks 150 kg	 fra 30 til 46	 fra 30 til 56	2 år	 På manuelle og elektriske rullestoler	



MÅL

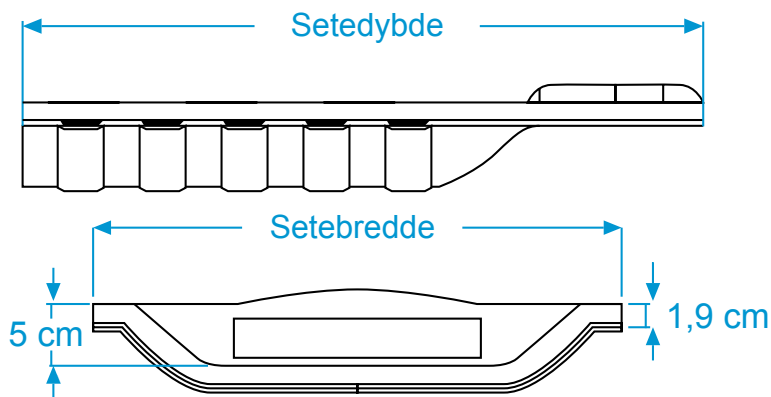

Rullestol-bredde	Sete-bredde	Sete-dybde
30 - 32 cm	30 cm (M1)	42 cm
34 - 36 cm	34 cm (M2)	46 cm
38 - 40 cm	38 cm (M3)	50 cm
42 - 44 cm	42 cm (M4)	52 cm
46 - 48 cm	46 cm (M5)	56 cm

MONTERINGSSYSTEM



MODULBASERT SETESYSTEM MED MODULÆRE INNLEGG



POLSTRING I TEMPUR OG PUSTENDE, SKLISIKKER OG BI-ELASTISK TREKK

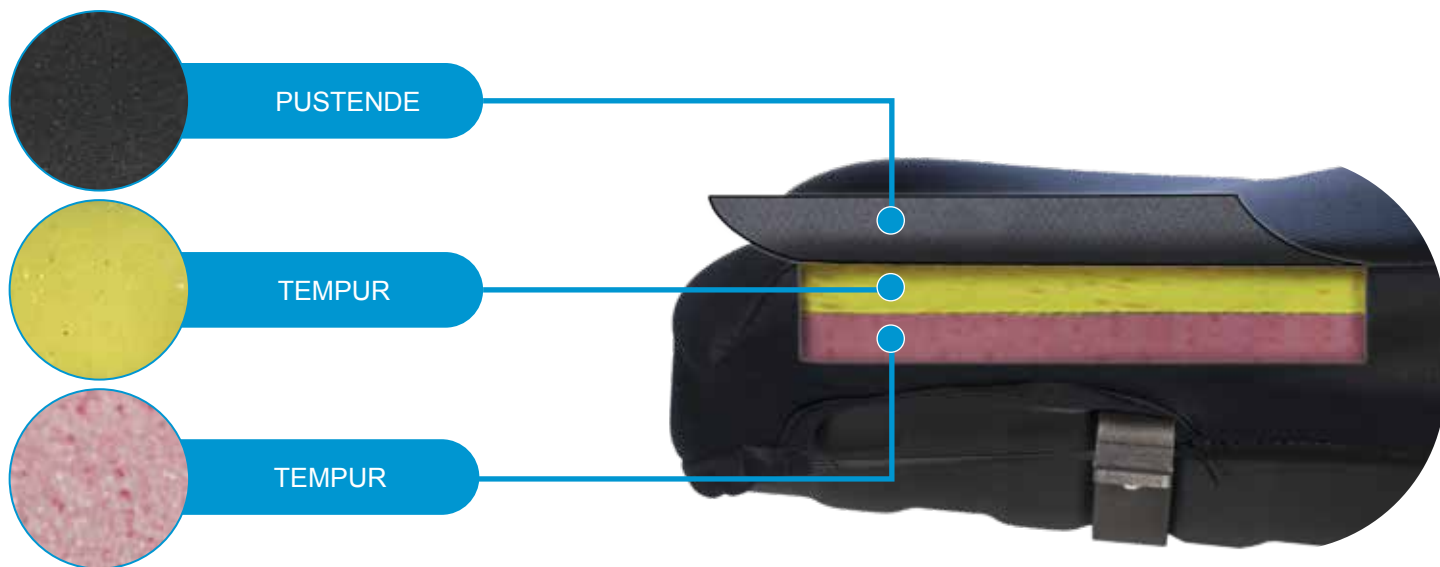

FORMSTØPT FAST BASE, IKKE-DEFORMERBART

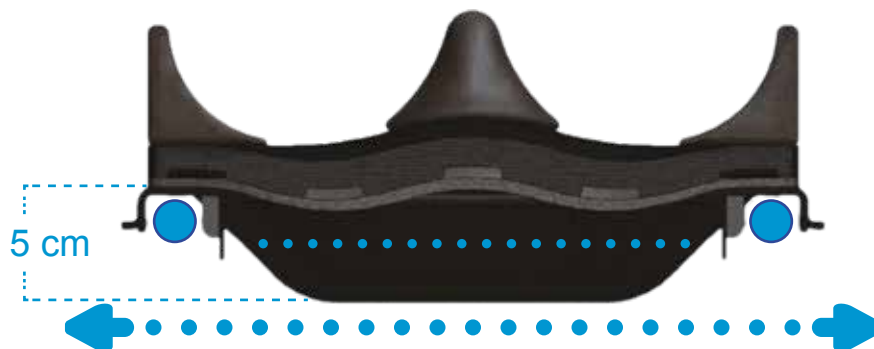

MODUL INNLEGG

DYBDEREDUSERENDE INNLEGG

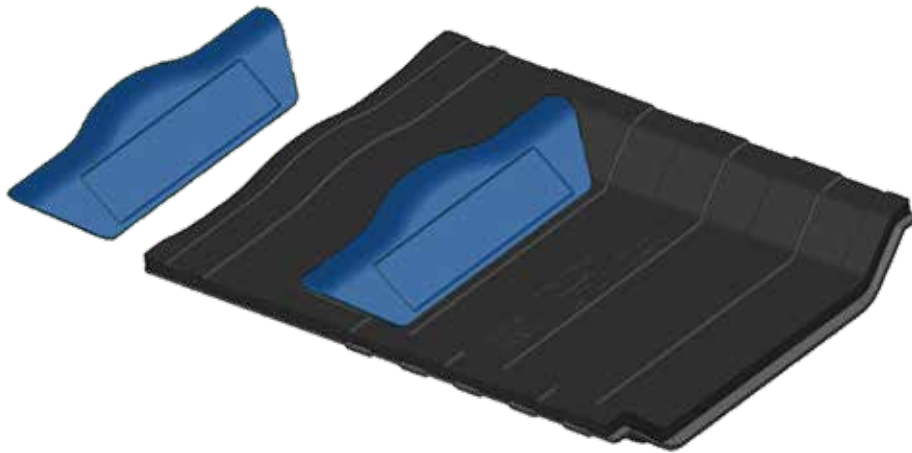

YTRE OG INDRE SIDESTØTTEINNLEGG FOR BEKKEN

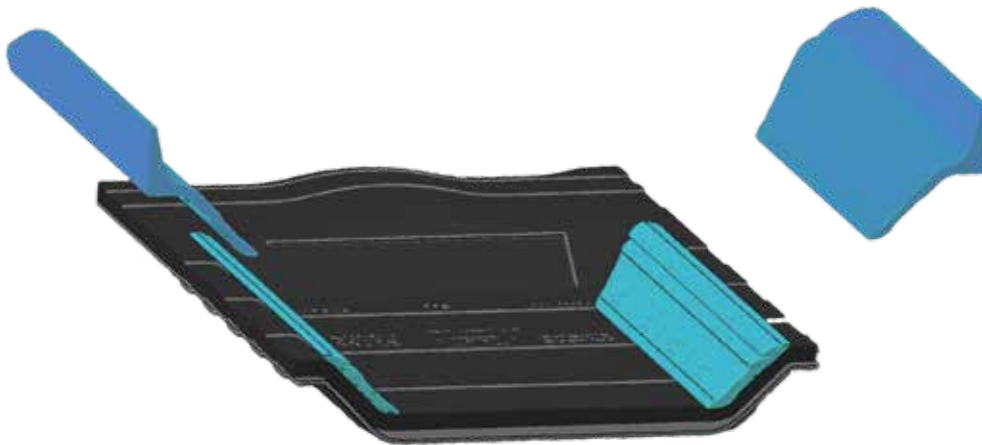

ADDUKSJON- OG ABDUKSJONSINNLEGG FOR BEN



OPTIMAL POSISJONERING AV BEKKEN



KLINISKE TILFELLER OG EKSEMPLER PÅ TILPASNING

BEKKENROTASJON



FORMBAR

BEKKENSKJEVHET

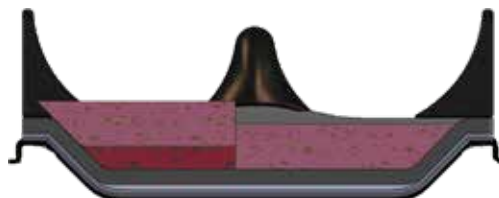

PEEZY



<p>Formbar</p>	<p>Trekk</p> <p>Sømløse pustende og vanntette</p>	<p>Vekt bruker</p> <p>Maks 150 kg</p>	<p>Sete-bredde</p> <p>← cm →</p> <p>fra 26 til 48</p>	<p>Sete-dybde</p> <p>↙ cm ↘</p> <p>fra 30 til 52</p>	<p>Garanti</p> <p>2</p> <p>år</p>	<p>Kollisjons-testet</p> <p>På manuelle og elektriske rullestoler</p>	<p>Sertifiseringer</p>	<p>Flammehemmende test</p> <p>laboratorium Rheinland</p> <p>TÜV-godkjent</p>

MÅL

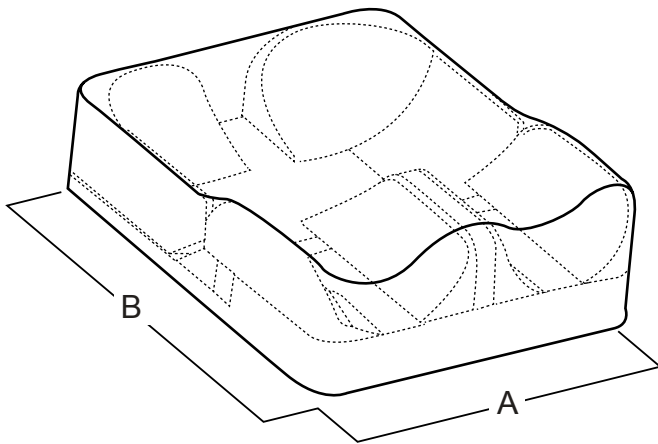

Størrelser Peezy	A	B
P1	26 cm	30 cm
P2	30 cm	34 cm
P3	30 cm	40 cm
P4	34 cm	44 cm
P5	36 cm	44 cm
P6	38 cm	48 cm
P7	42 cm	44 cm
P8	42 cm	52 cm
P9	44 cm	50 cm
P10	48 cm	52 cm

MONTERINGSSYSTEMER



FORMBARE, TILPASNINGSDYKTIGE MODULER FOR Å IMØTEKOMME ALVORLIGE MISDANNELSER

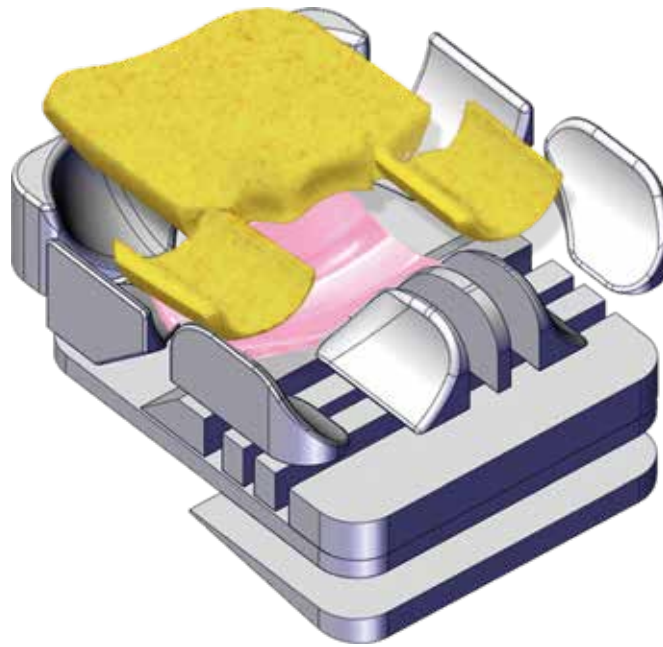

POLSTRING I TEMPUR OG PUSTENDE, SKLISIKKER OG BI-ELASTISK TREKK

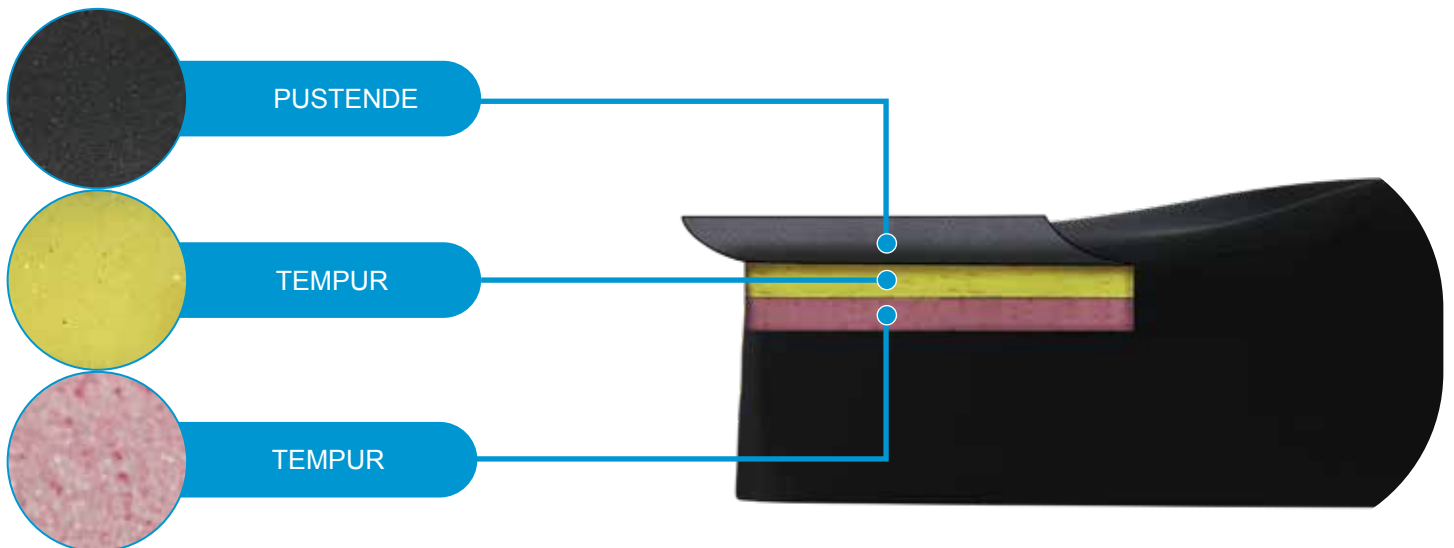

POSISJONERINGSPUTE MED FLAT SETEBUNN



MODUL INNLEGG

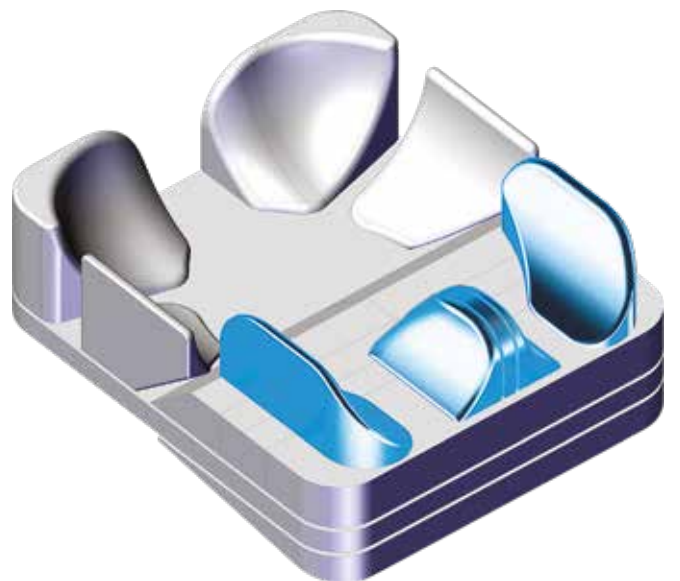
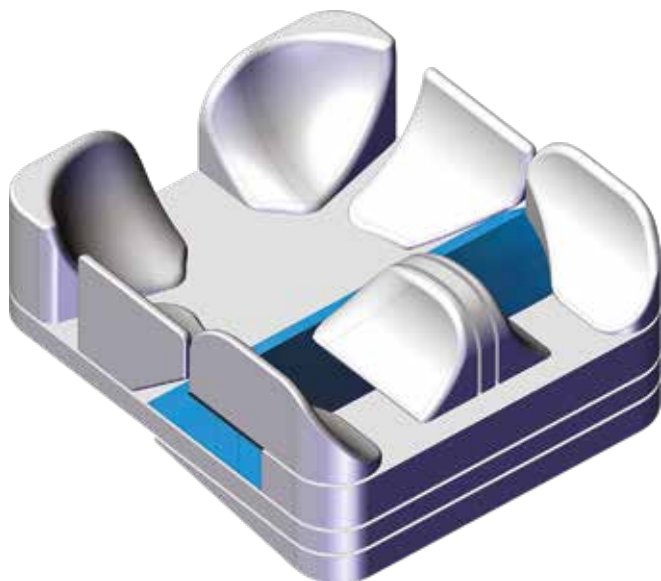
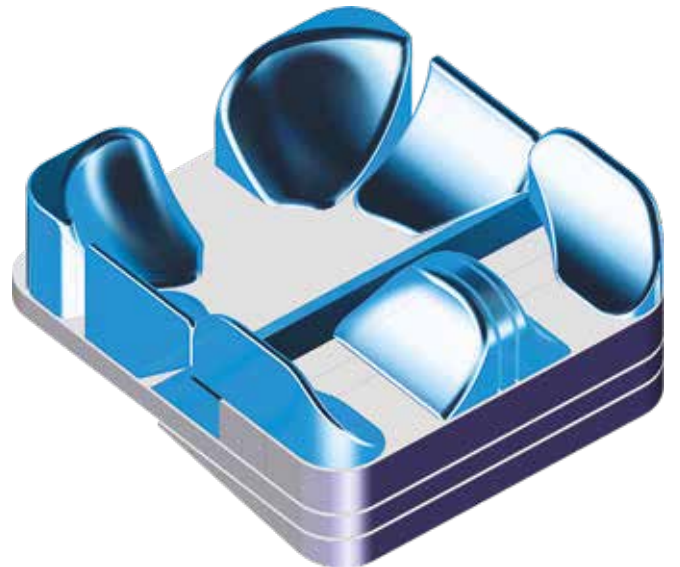
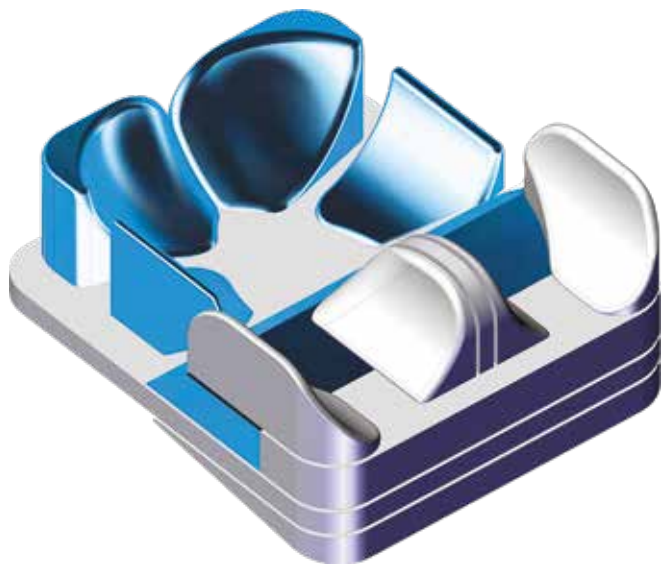

KLINISKE TILFELLER OG EKSEMPLER PÅ TILPASNING

ABDUKSJON

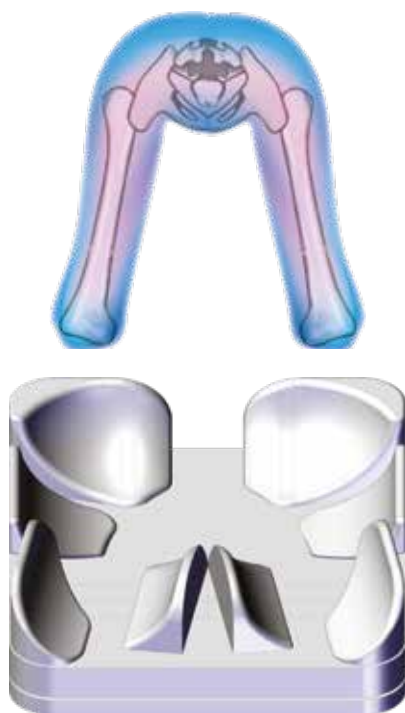

VERTIKAL BEKKENROTASJON

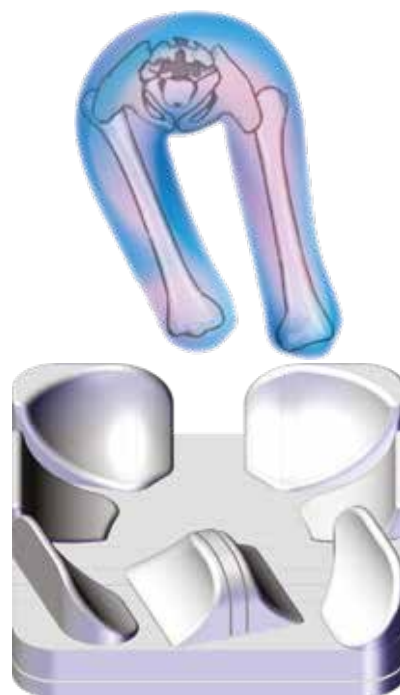

ASYMMETRI



HORISONTAL BEKKENSKJEVHET



PEEZY LIGHT





PEEZY LIGHT

SETEPUTER

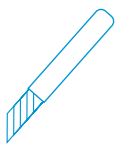

Formbar

Trekk	Vekt bruker	Sete-bredde	Sete-dybde	Garanti	Kollisjons-testet	Sertifiseringer	Flammehemmende test
Sømløse pustende og vanntette	Maks 150 kg	← cm → fra 26 til 48	↙ cm ↘ fra 30 til 52	2 år	På manuelle og elektriske rullestoler	CE	laboratorium Rheinland TÜV-godkjent



MÅL

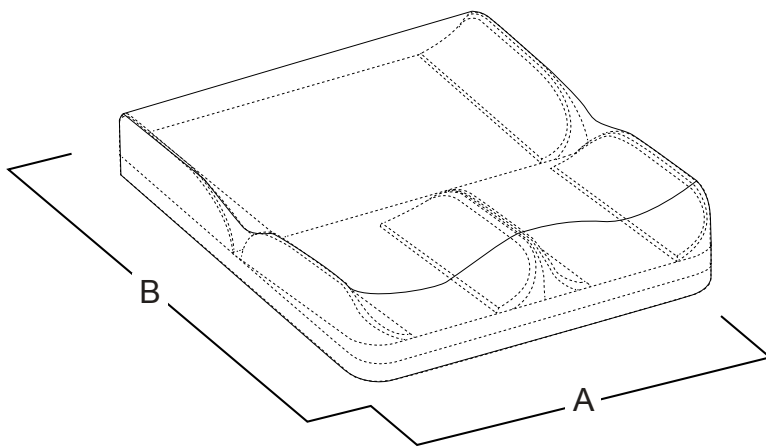

Størrelser Peezy	A	B
P1	26 cm	30 cm
P2	30 cm	34 cm
P3	30 cm	40 cm
P4	34 cm	44 cm
P5	36 cm	44 cm
P6	38 cm	48 cm
P7	42 cm	44 cm
P8	42 cm	52 cm
P9	44 cm	50 cm
P10	48 cm	52 cm

MONTERINGSSYSTEMER



MODULBASERT SETESYSTEM MED MODULÆRE INNLEGG

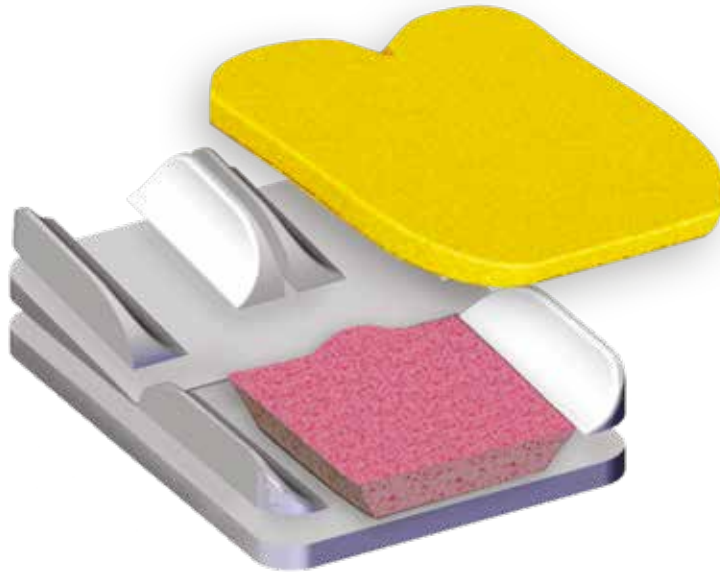

POLSTRING I TEMPUR OG PUSTENDE, SKLISIKKER OG BI-ELASTISK TREKK

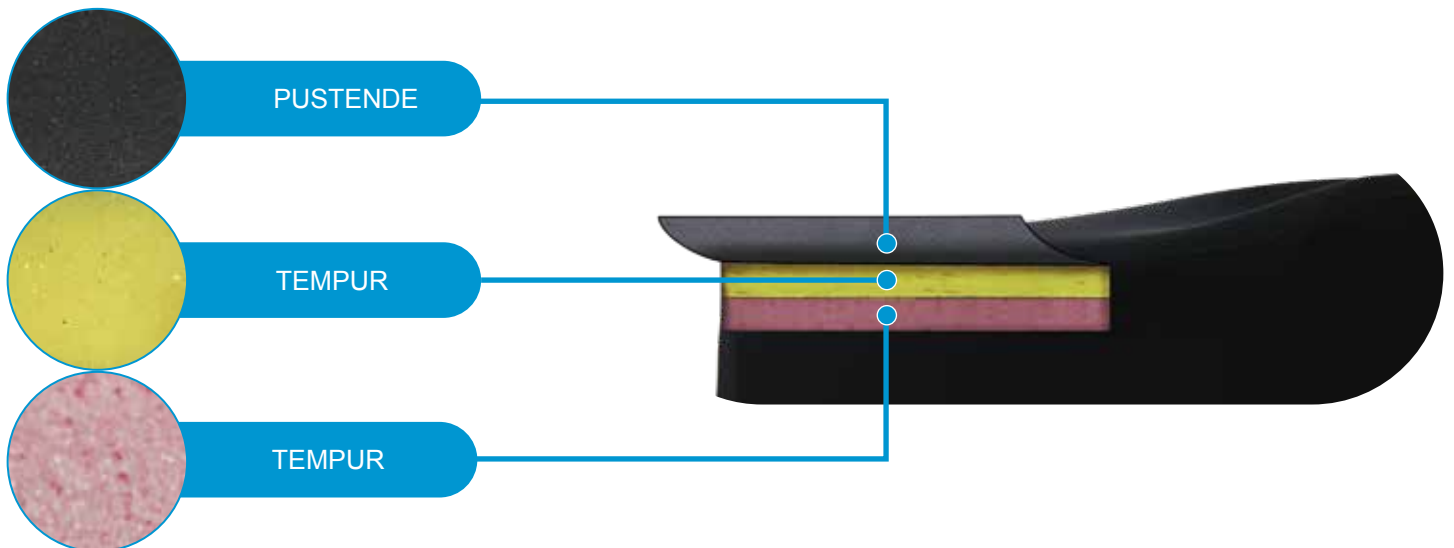

POSISJONERINGSPUTE MED FLAT SETEBUNN

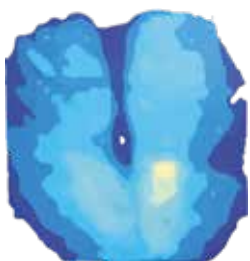



MODUL INNLEGG

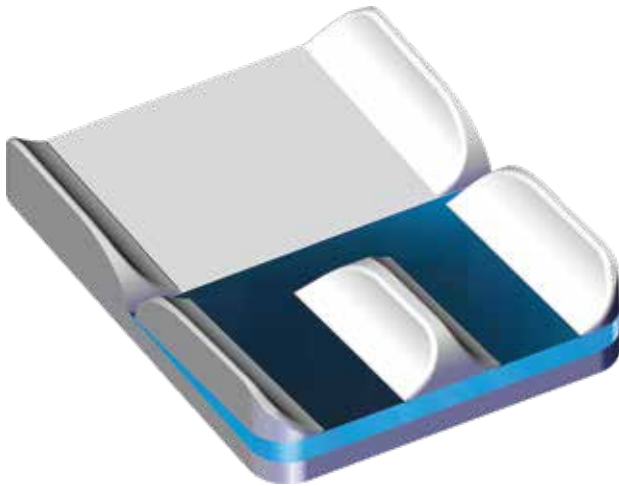
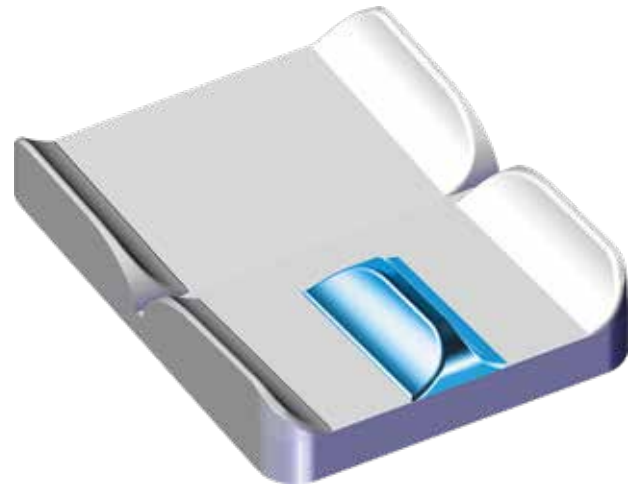
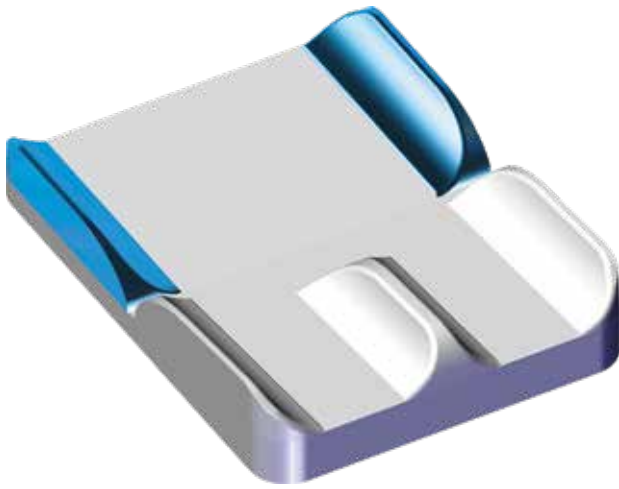

KLINISKE TILFELLER OG EKSEMPLER PÅ TILPASNING

ABDUKSJON

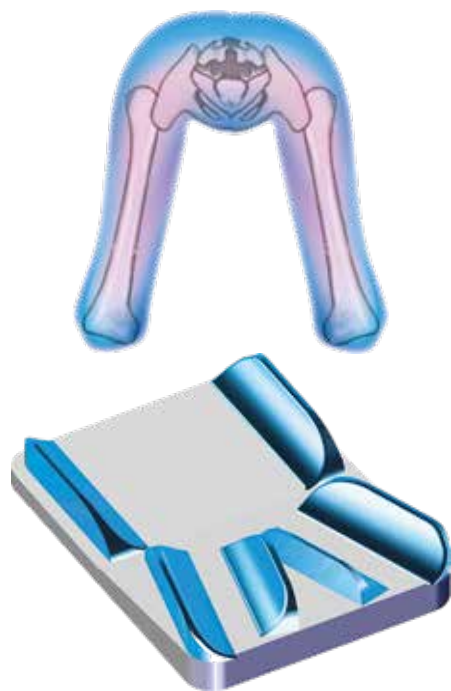

VERTIKAL BEKKENROTASJON

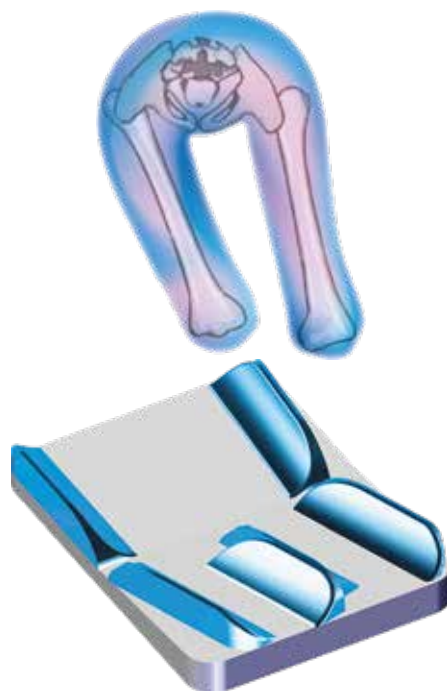

ASYMMETRI

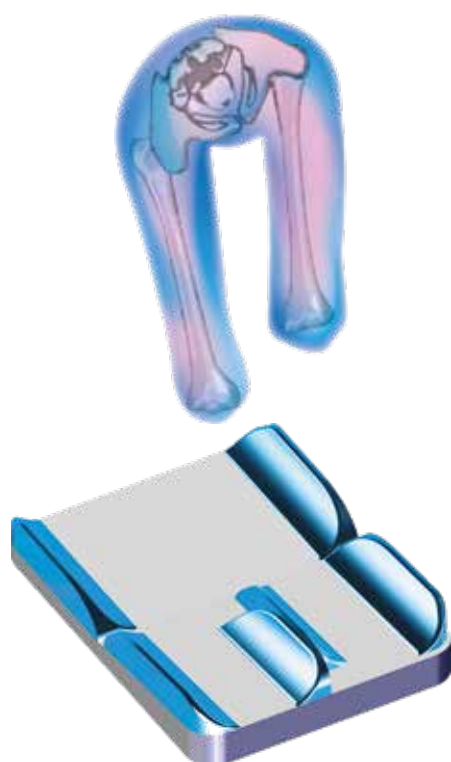

HORISONTAL BEKKENSKJEVHET



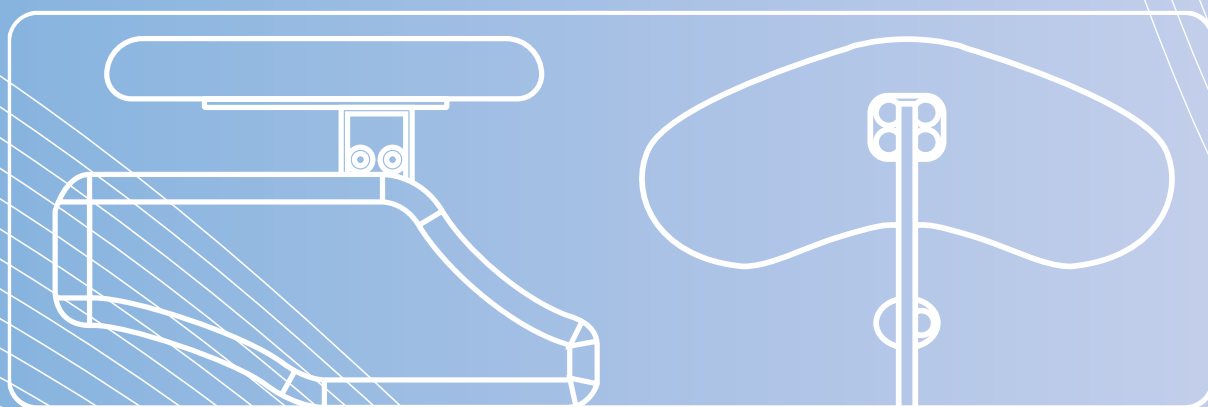
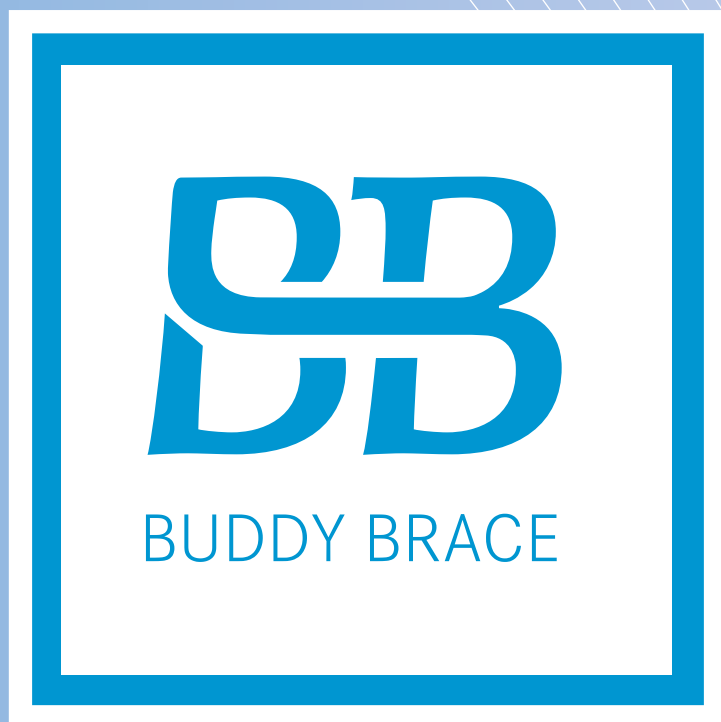

**HODESTØTTER,
ARMLENER & TILBEHØR**

TILBEHØR



HODESTØTTEFESTE KOMPATIBELT MED DE FLESTE RYGGSTØTTER



MONTERINSSYSTEM



STANDARD KOBLING

Bredde	Høyde	Hull
9 cm	4,5 cm	M5

UNIVERSAL KOBLING

Bredde	Høyde	Hull
9 cm	11 cm	M6

HODESTØTTE MED ORBITAL BEVEGELSE

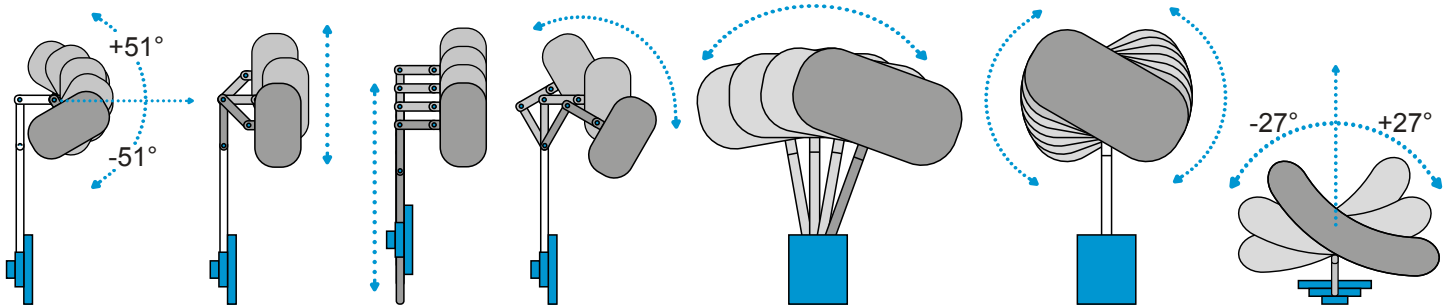

POLSTRING I TEMPUR OG PUSTENDE OG AVTAGBAR TREKK

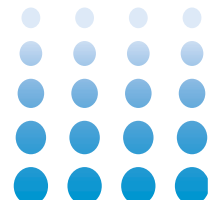
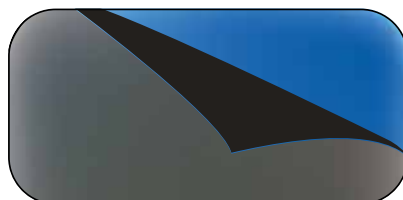

HODESTØTTE PAD

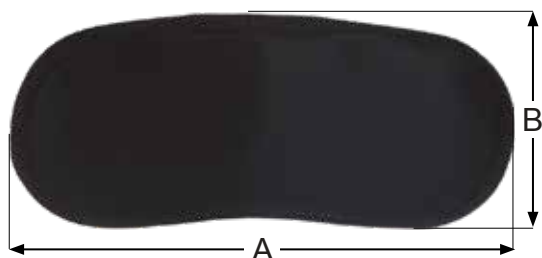

PAD I TEMPUR "STRAIGHT"

	liten	medium	stor
A	23 cm	34 cm	42 cm
B	9 cm	16 cm	18 cm

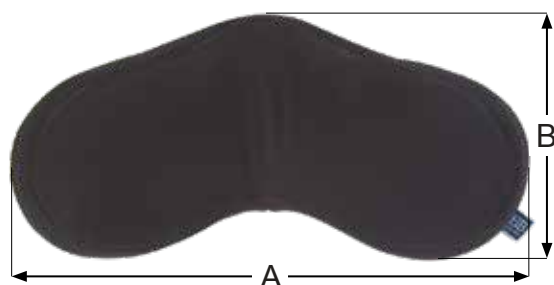

PAD I TEMPUR "CURVED"

	liten	medium	stor
A	23 cm	34 cm	42 cm
B	12 cm	18 cm	22 cm

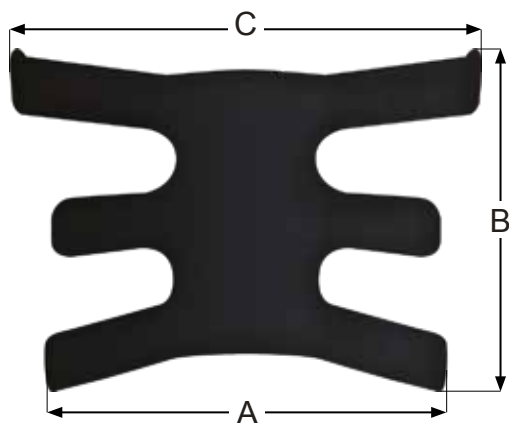

*** PAD "E"**

	liten	medium	stor
A	15 cm	18 cm	26 cm
B	13 cm	16 cm	18 cm
C	18 cm	21 cm	22 cm

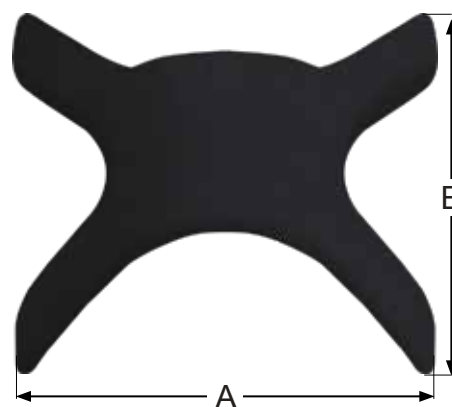

*** PAD "X"**

	liten	medium
A	20 cm	25 cm
B	17 cm	21 cm

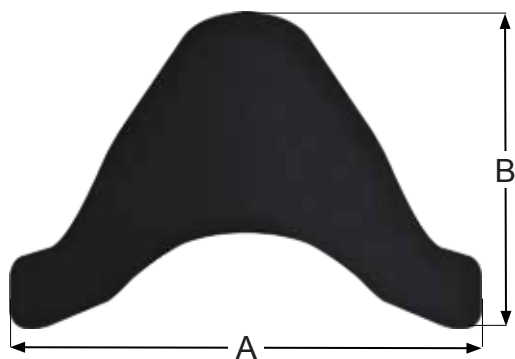

PAD "A"

	liten	medium
A	21 cm	26 cm
B	14 cm	17 cm



*** KOMPATIBLE
MED HODEBÅND**

HODESTØTTEBRAKETTER

"FREE-SHOCK" BRAKETT

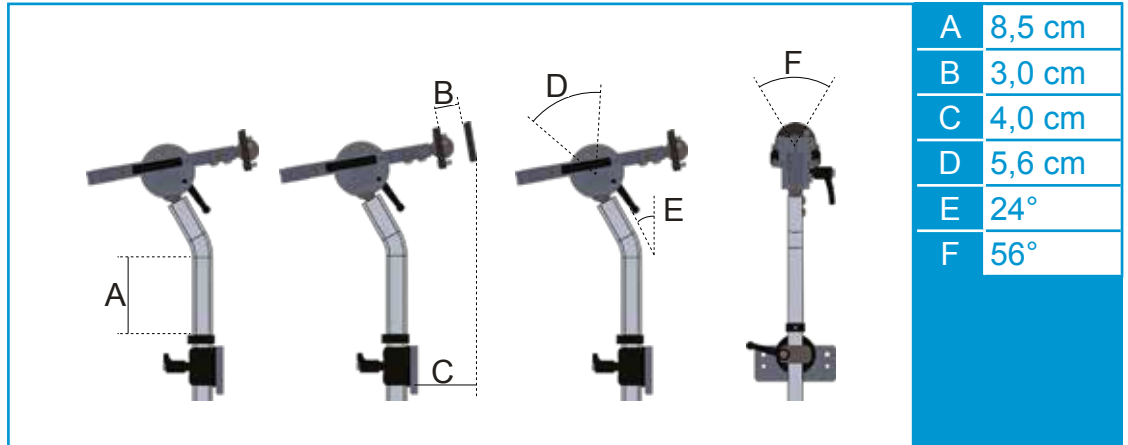

"I" BRAKETT

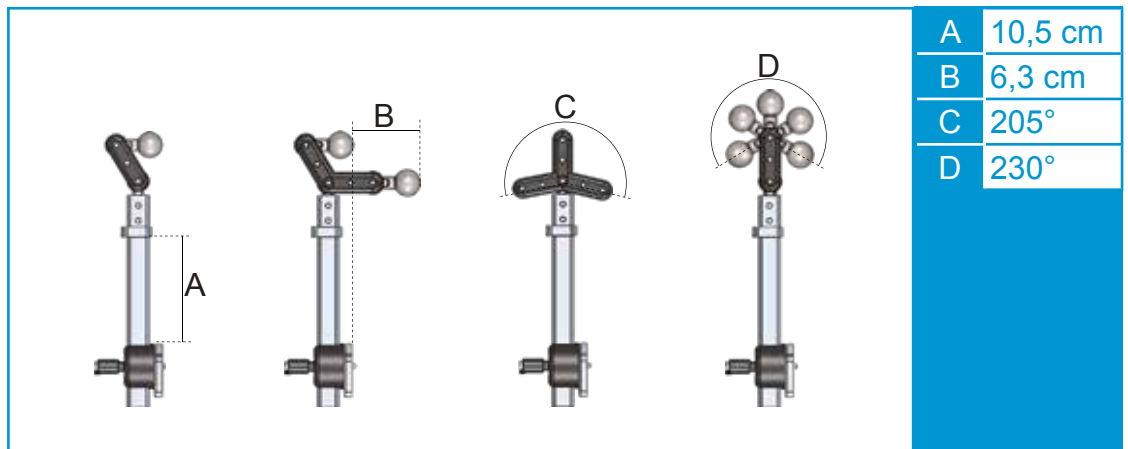
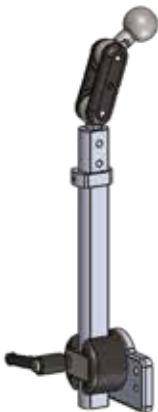

"C" BRAKETT

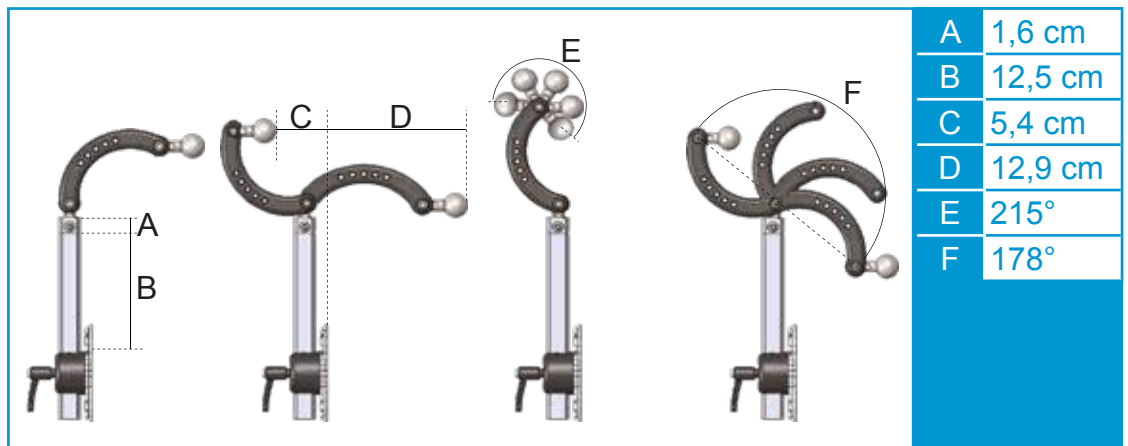

HODESTØTTEBRAKETTER

"I-C" BRAKETT

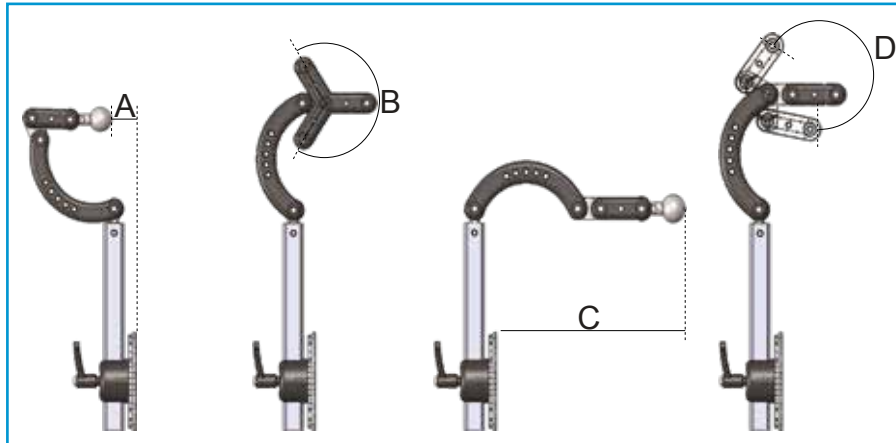

A	2,6 cm
B	242°
C	19,5 cm
D	244°

"C-C" BRAKETT

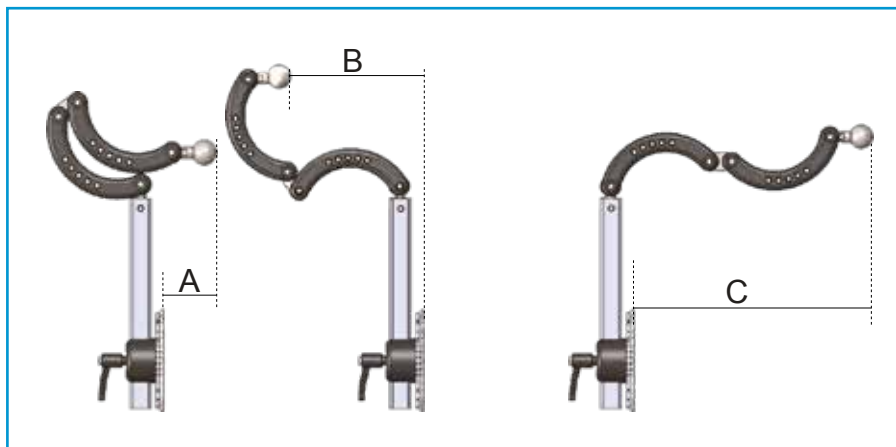

A	5,3 cm
B	13,8 cm
C	25,3 cm

"T" BRAKETT

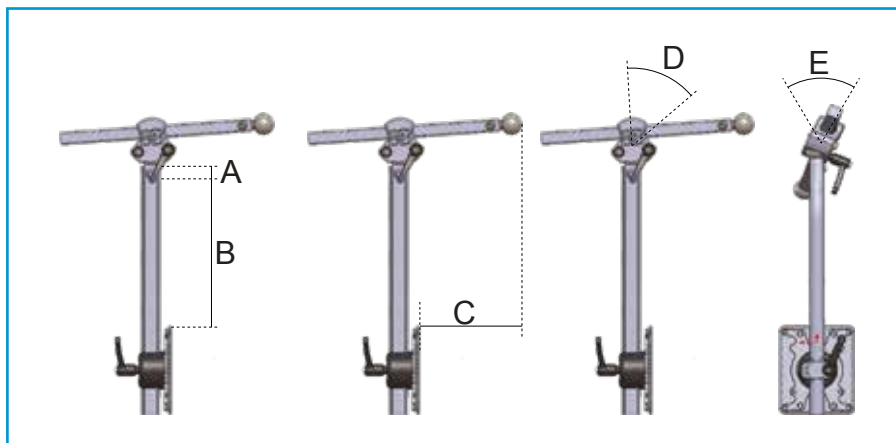

A	1,6 cm
B	12,5 cm
C	21,2 cm
D	56°
E	56°

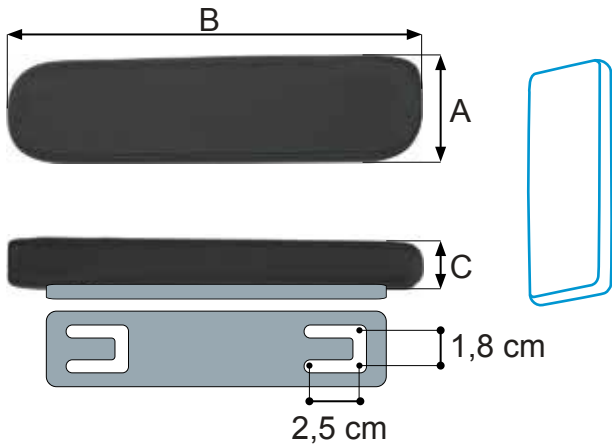

POLSTRET				
	XS	S	M	L
A	5 cm	7 cm	7 cm	11 cm
B	25 cm	30 cm	40 cm	35 cm
C	4 cm	4 cm	4 cm	4 cm

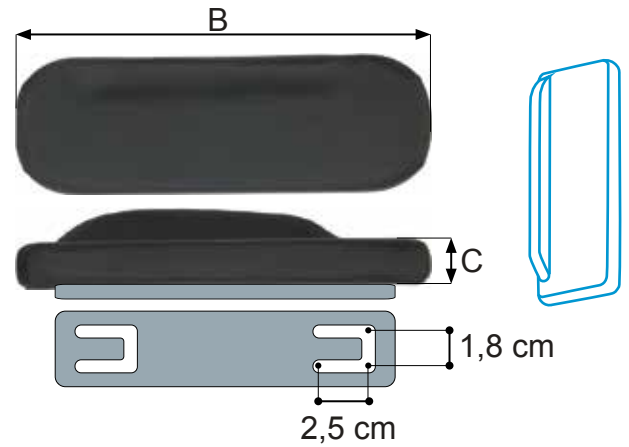

POLSTER MED 1 SIDESTØTTE		
	S	L
A	9 cm	12 cm
B	30 cm	40 cm
C	6 cm	6 cm

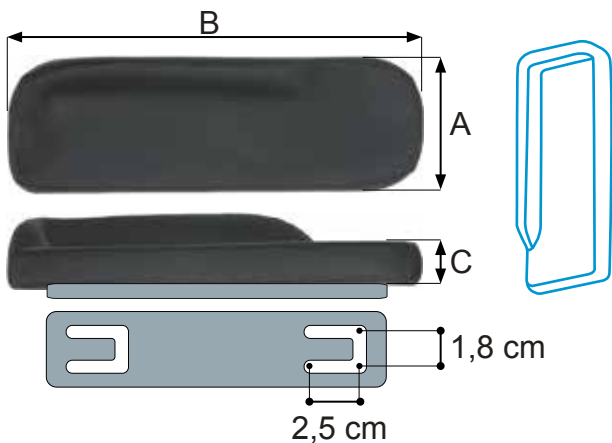

POLSTER MED 2 SIDESTØTTER		
	S	L
A	9 cm	12 cm
B	30 cm	40 cm
C	5 cm	5 cm

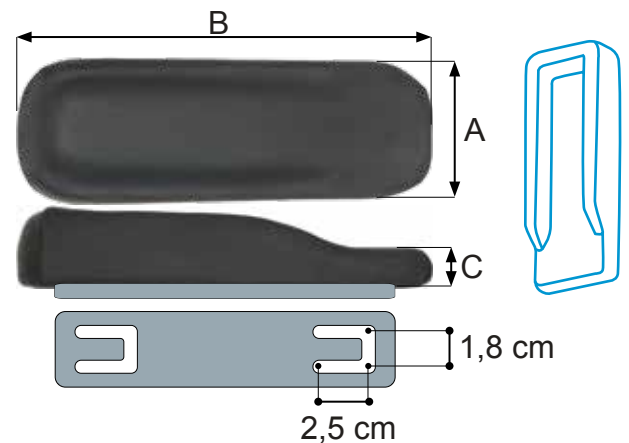

POLSTER MED 3 SIDESTØTTER			
	S	M	L
A	9 cm	11,5 cm	13 cm
B	35 cm	35 cm	40 cm
C	5 cm	5 cm	5 cm

ARMLENERSTØTTE OG BEVEGELSER

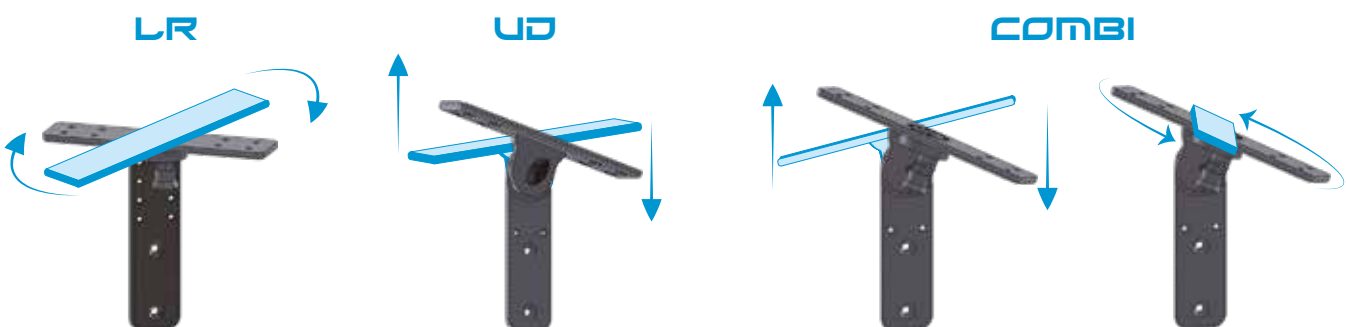

STØTTE-TILBEHØR

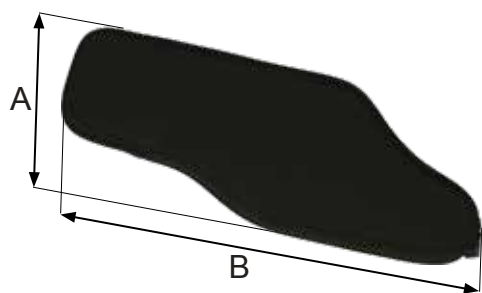

POLSTRET SIDESTØTTE		
	liten	stor
A	11 cm	13 cm
B	30 cm	35 cm
Tykkelse	3,5 cm	3,5 cm

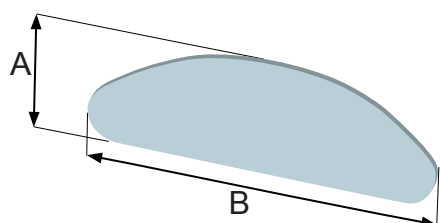

LITEN SIDESTØTTE I P.E.T.G.	
A	9 cm
B	27 cm
Tykkelse med polstring	2 cm

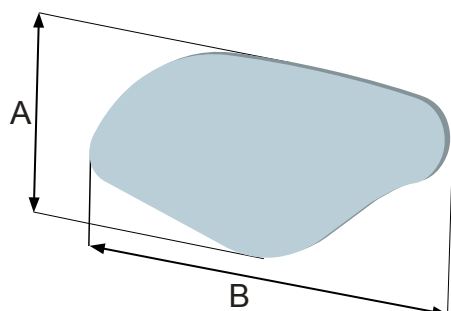
STOR SIDESTØTTE I P.E.T.G.	
A	15 cm
B	31 cm
Tykkelse med polstring	2 cm



ABDUKSJONS-KLOSS

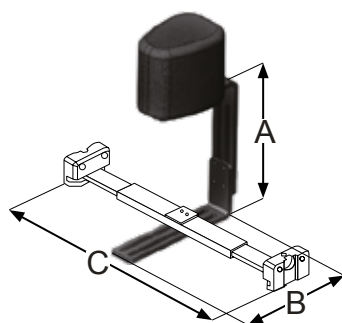

	liten	stor
A	11 cm	13 cm
B	30 cm	35 cm
C	3,5 cm	3,5 cm

LEDDPOLSTRING

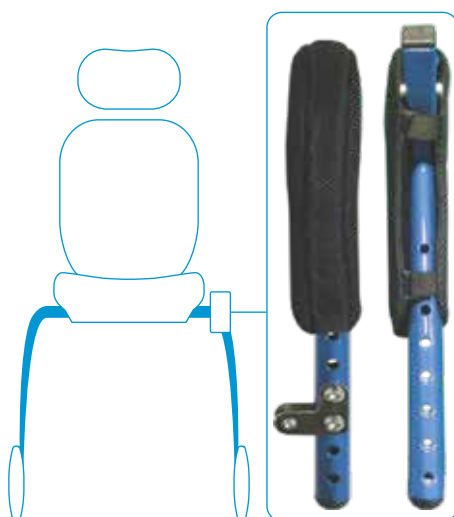

KNESTØTTER

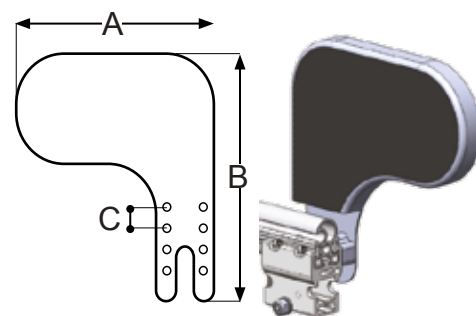

A	21 cm
B	26 cm
C	2 cm

BORD I P.E.T.G.

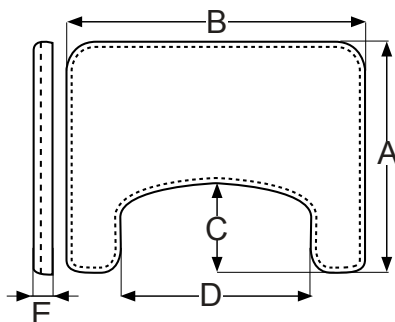
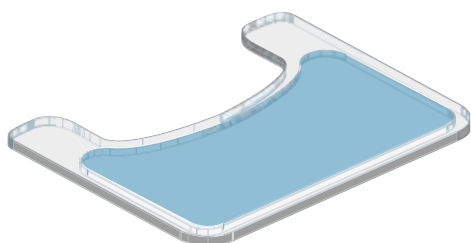

A	48 cm
B	62 cm
C	18,6 cm
D	39,5 cm
E	2 cm

FORMET BORD I P.E.T.G.

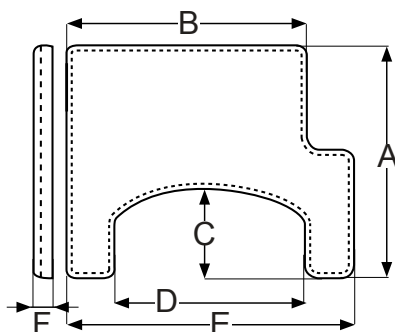
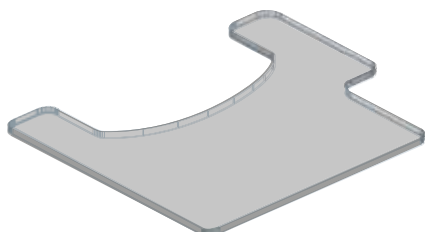

	liten	stor
A	41 cm	49 cm
B	42 cm	50 cm
C	16 cm	21 cm
D	33 cm	40 cm
E	50 cm	60 cm
F	0,8 cm	0,8 cm

POLSTRET BORD I IMITERT SKINN

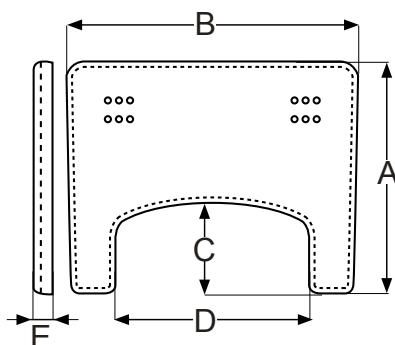

	liten	medium	stor
A	48 cm	48 cm	48 cm
B	60 cm	65 cm	70 cm
C	19 cm	19 cm	19 cm
D	40 cm	45 cm	50 cm
E	2 cm	2 cm	2 cm

MONTERINGSSYSTEM

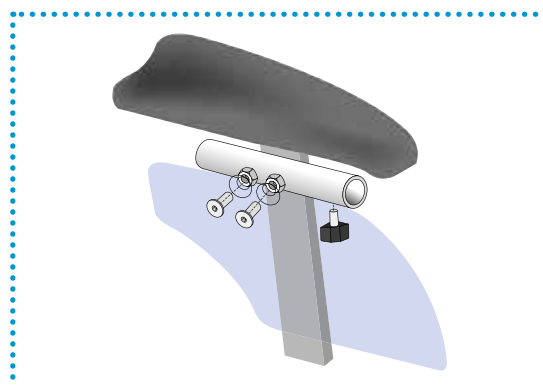
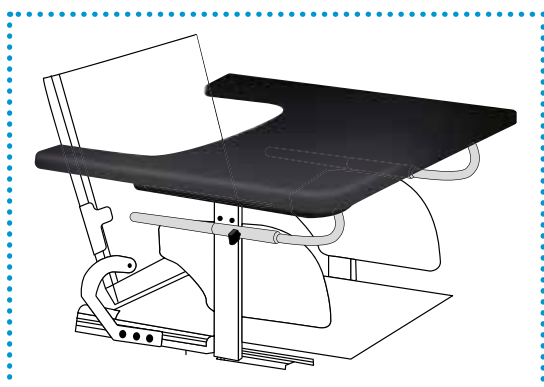

VESKER



VESKE MED EN LOMME			
	liten	stor	
Bredde	28 cm	24 cm	
Høyde	12 cm	12 cm	
Dybde	8 cm	8 cm	



INTERN VESKE			
	liten	stor	
Bredde	22 cm	30 cm	
Høyde	18 cm	22 cm	
Dybde	3 cm	3 cm	



HARD VESKE			
	liten	stor	
Bredde	20 cm	30 cm	
Høyde	18 cm	22 cm	
Dybde	10 cm	10 cm	



VANNTETT VESKE			
	liten	stor	
Bredde	22 cm	26 cm	
Høyde	12 cm	15 cm	
Dybde	12 cm	12 cm	



VESKE I IMITERT SKINN			
	liten	stor	
Bredde	30 cm	33 cm	
Høyde	20 cm	22 cm	
Dybde	8 cm	8 cm	



RYGGSEKK OG OKSYGENFLASKEHOLDER			
	liten	stor	
Bredde	30 cm	40 cm	
Høyde	29 cm	35 cm	
Dybde	15 cm	15 cm	

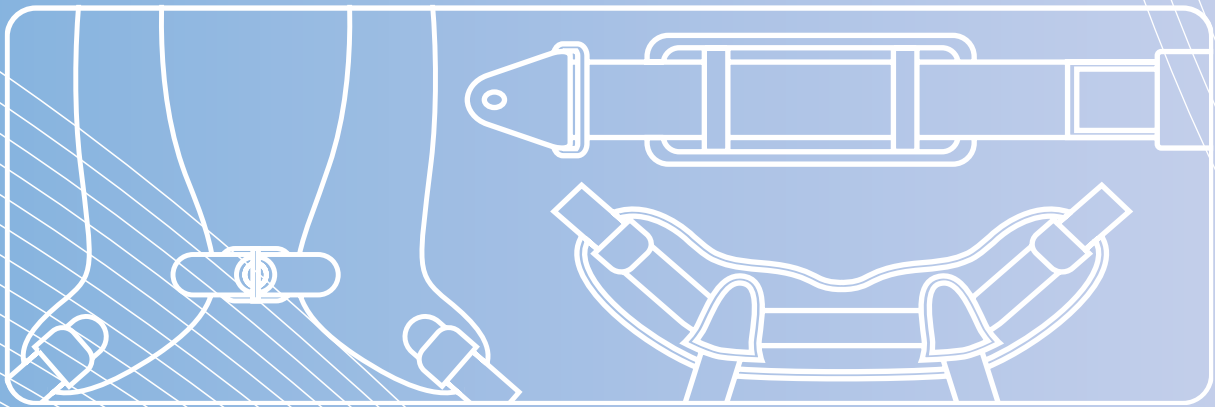
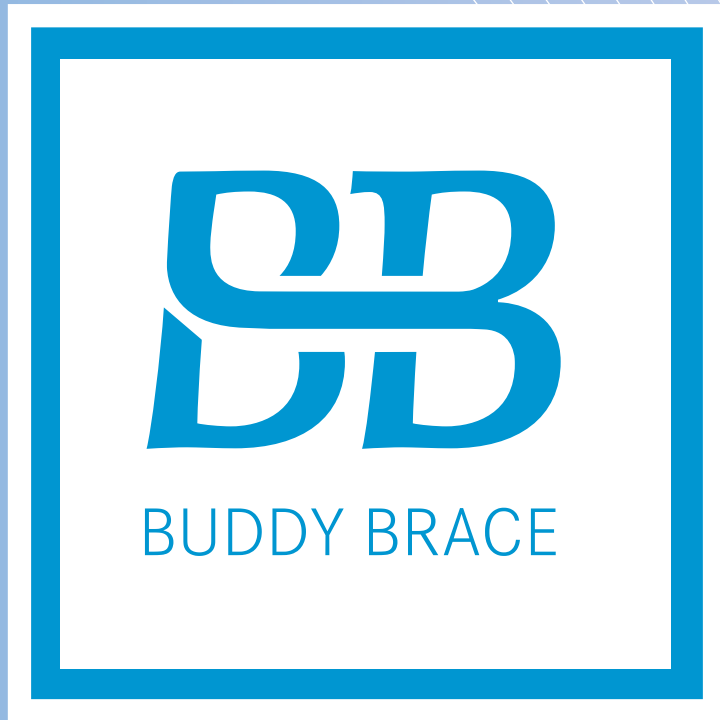

BELTER

HODEBÅND

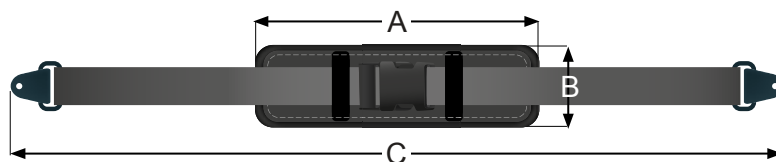

	liten	stor
A	15 cm	20 cm
B	5 cm	5 cm
C	40 - 45 cm	45 - 50 cm

BRYSTBELTER

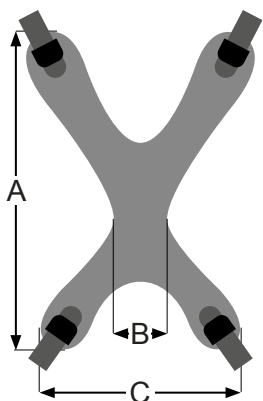

BUTTERFLY X

	liten	medium	stor
A	31 cm	41 cm	51 cm
B	5 cm	6 cm	7 cm
C	27 cm	29 cm	37 cm

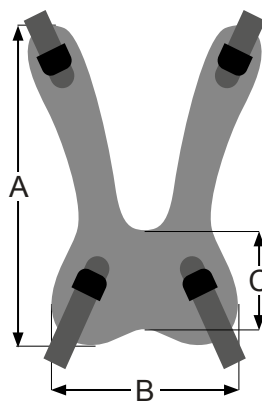

BUTTERFLY U

	liten	medium	stor
A	31 cm	41 cm	51 cm
B	21 cm	28 cm	36 cm
C	8 cm	10 cm	12 cm

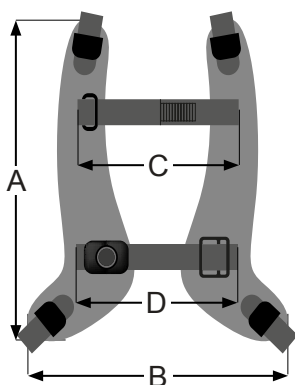

BUTTERFLY H

	liten	medium	stor
A	31 cm	41 cm	51 cm
B min	23 cm	27 cm	35 cm
B maks	31 cm	39 cm	51 cm
C strap	18 cm	28 cm	38 cm
D strap	20 cm	25 cm	30 cm

MONTERINGSSYSTEM

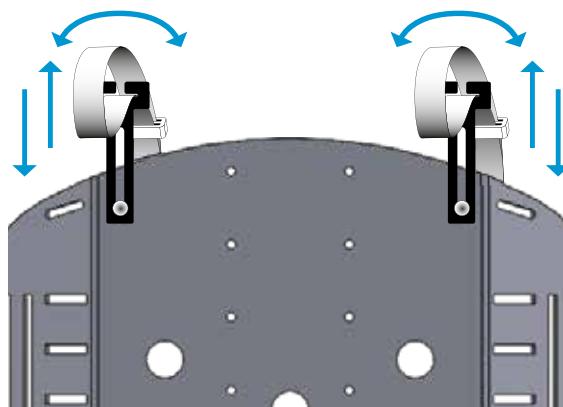

2-PUNKTS HOFTEBELTER

METALLSPENNE

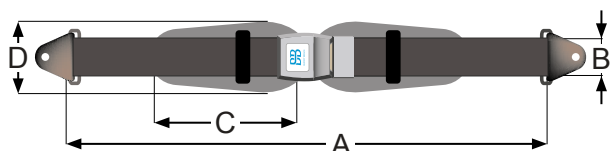

	liten	stor
A	130 - 140 cm	150 - 160 cm
B	2,5 cm	4 cm
C	20 cm	25 cm
D	4 cm	8 cm

PLASTSPENNE

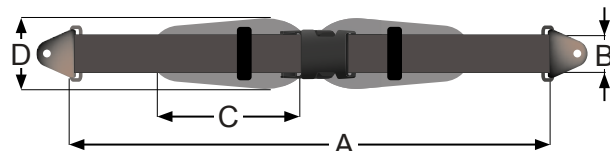

	liten	stor
A	130 - 140 cm	150 - 160 cm
B	2,5 cm	4 cm
C	20 cm	25 cm
D	4 cm	8 cm

4-PUNKTS HOFTEBELTER

METALLSPENNE

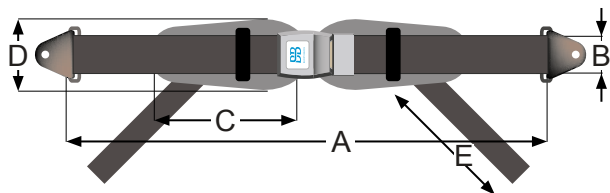

	liten	stor
A	130 - 140 cm	150 - 160 cm
B	2,5 cm	4 cm
C	20 cm	25 cm
D	4 cm	8 cm
E	80 cm	80 cm

PLASTSPENNE

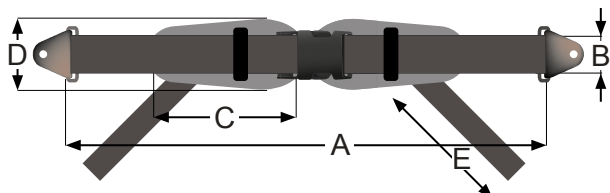

	liten	stor
A	130 - 140 cm	150 - 160 cm
B	2,5 cm	4 cm
C	20 cm	25 cm
D	4 cm	8 cm
E	80 cm	80 cm

ARMHOLDER

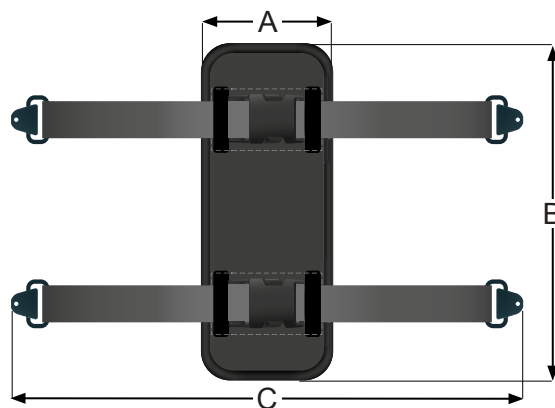

	liten	stor
A	15 cm	20 cm
B	7 cm	10 cm
D	25 - 30 cm	30 - 35 cm

POLSTRET LEGGSTROPP

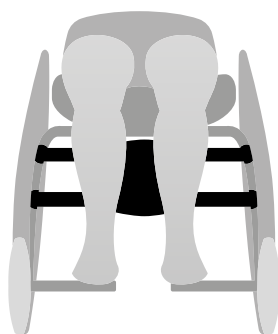

LITEN

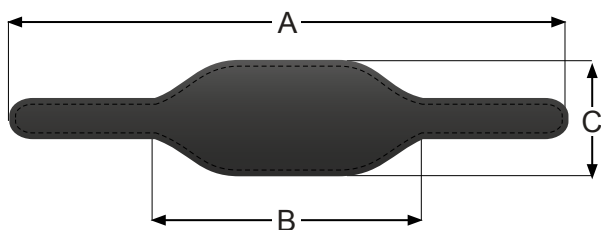

	liten
A	80 cm
B	36 cm
D	19 cm

MEDIUM/STOR

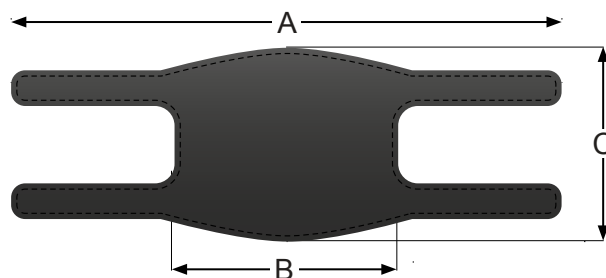

	medium	stor
A	90 cm	100 cm
B	41 cm	40 cm
D	21 cm	23 cm

ANKELBELTE

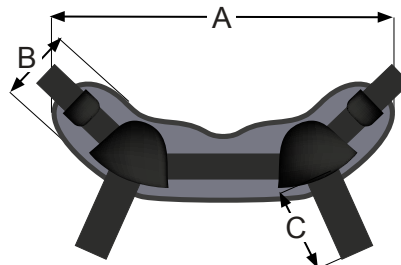
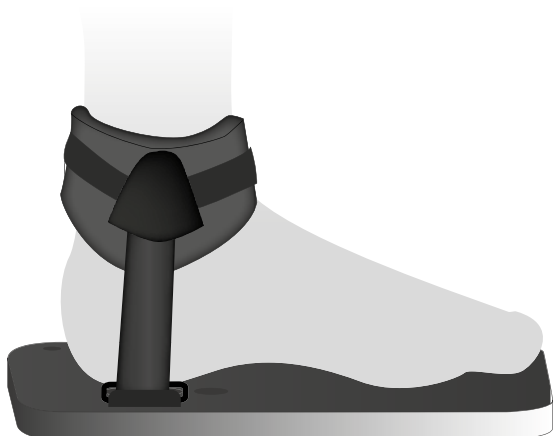

	liten	medium	stor
A	23 - 28 cm	27 - 34 cm	29 - 38 cm
B	6,5 cm	6,5 cm	6,5 cm
C	15 cm	18 cm	20 cm

FOTSTROPPE

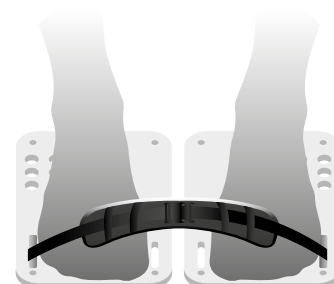
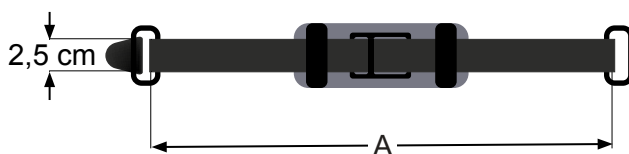

for en fot			
	liten	medium	stor
C	12 - 16 cm	15 - 19 cm	18 - 22 cm

for to føtter			
	liten	medium	stor
C	25 - 29 cm	30 - 34 cm	35 - 39 cm

HÆLSTROPPE

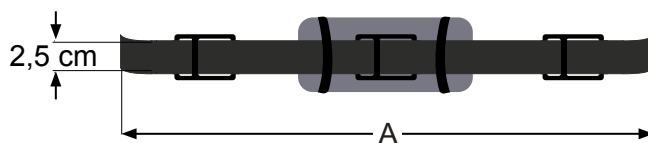

for en fot	
A	30 cm

for to føtter	
A	60 cm

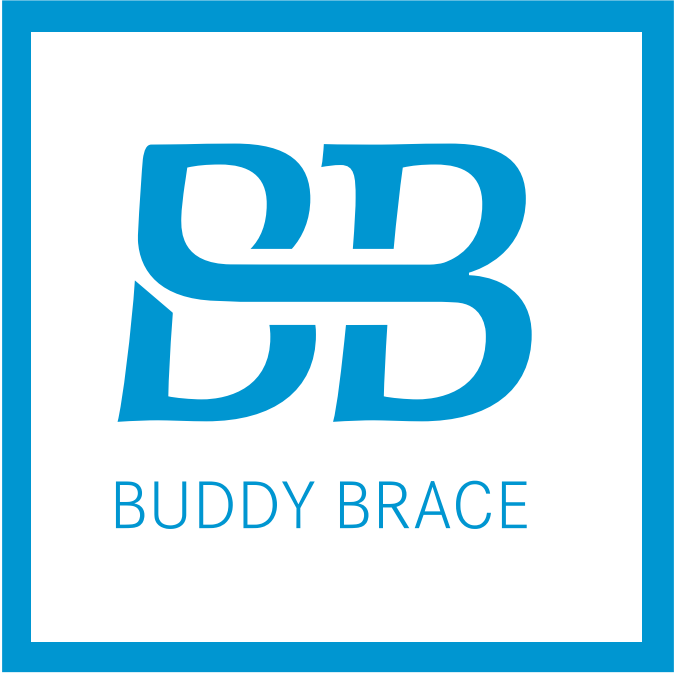

BUDDY BRACE